

# HJ Series

---

## METAL JOINTS



# METAL JOINTS



SURFACE : ●BK ○WZ ○NP ○CP ●PC

HJ-1

H-1 : 2 Pcs	kg/Set : 0.145
N-1/N-2 : 1 Set	Sets/Ctn : 4 / 140

HJ-1A

H-1A : 2 Pcs	kg/Set : 0.130
N-1/N-2 : 1 Set	Sets/Ctn : 4 / 170

HJ-2

H-2 : 1 Pc	kg/Set : 0.235
H-3 : 1 Pc	Sets/Ctn : 4 / 50
N-1/N-2 : 2 Sets	

HJ-3

H-2 : 2 Pcs	kg/Set : 0.325
H-4 : 1 Pc	Sets/Ctn : 4 / 60
N-1/N-2 : 3 Sets	

HJ-4

H-4 : 2 Pcs	kg/Set : 0.235
N-1/N-2 : 2 Sets	Sets/Ctn : 4 / 90

HJ-5

H-2 : 4 Pcs	kg/Set : 0.420
N-1/N-2 : 4 Sets	Sets/Ctn : 4 / 45

HJ-6

H-5 : 2 Pcs	kg/Set : 0.230
H-6 : 2 Pcs	Sets/Ctn : 4 / 70
N-1/N-2 : 2 Sets	

HJ-6A

H-6 : 2 Pcs	kg/Set : 0.280
H-6A : 2 Pcs	Sets/Ctn : 4 / 60
N-1/N-2 : 3 Sets	

HJ-6B

H-5 : 2 Pcs	kg/Set : 0.100
N-1/N-2 : 1 Set	Sets/Ctn : 4 / 140

HJ-6C

H-6A : 2 Pcs	kg/Set : 0.160
N-1/N-2 : 2 Sets	Sets/Ctn : 4 / 110

HJ-7

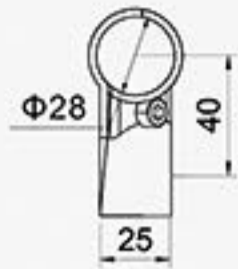

H-7 : 2 Pcs	kg/Set : 0.110
N-1/N-2 : 1 Set	Sets/Ctn : 4 / 90

HJ-7A

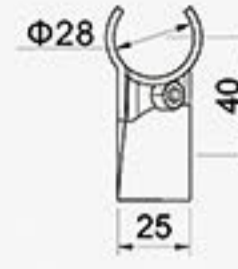

H-7A : 2 Pcs	kg/Set : 0.090
N-1/N-2 : 1 Set	Sets/Ctn : 4 / 140

HJ-8

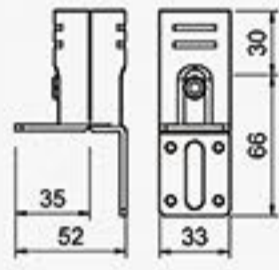

H-8 : 1 Pc	kg/Set : 0.140
H-9 : 1 Pc	Sets/Ctn : 4 / 130
N-1/N-2 : 1 Set	

HJ-9

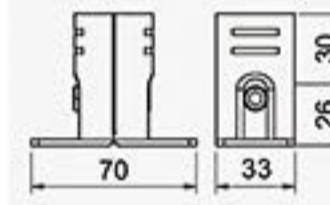

H-9 : 2 Pcs	kg/Set : 0.135
N-1/N-2 : 1 Set	Sets/Ctn : 4 / 150

HJ-10

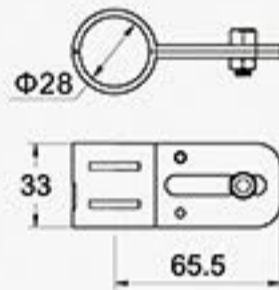

H-10 : 2 Pcs	kg/Set : 0.120
N-1/N-2M612 : 1 Set	Sets/Ctn : 4 / 150

HJ-11

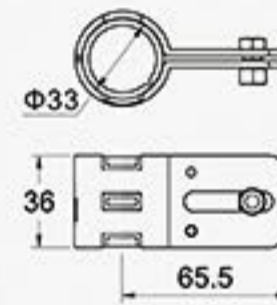

H-11 : 2 Pcs	kg/Set : 0.140
P-6 : 1 Pc	Sets/Ctn : 4 / 80
N-1/N-2M612 : 1 Set	

HJ-12

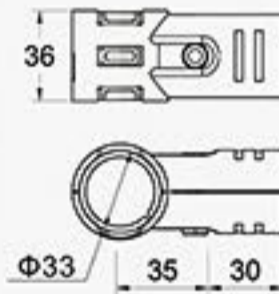

H-12 : 2 Pcs	kg/Set : 0.150
P-6 : 1 Pc	Sets/Ctn : 4 / 70
N-1/N-2 : 1 Set	

HJ-13

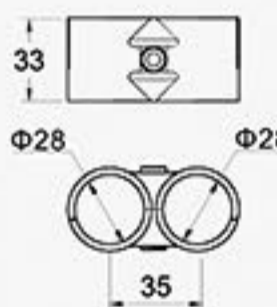

H-13 : 2 Pcs	kg/Set : 0.120
N-1/N-2 : 1 Set	Sets/Ctn : 4 / 140

HJ-13A

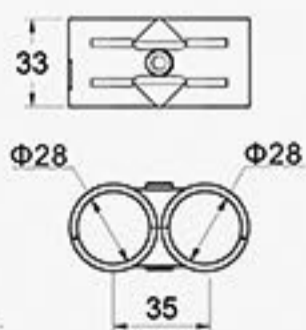

H-13A : 2 Pcs	kg/Set : 0.120
N-1/N-2 : 1 Set	Sets/Ctn : 4 / 140

HJ-13B

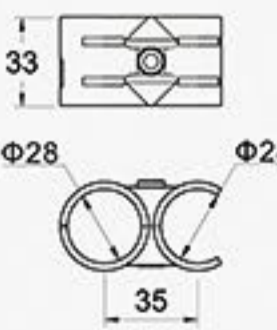

H-13B : 2 Pcs	kg/Set : 0.120
N-1/N-2 : 1 Set	Sets/Ctn : 4 / 250

# METAL JOINTS



SURFACE : ●BK ○WZ ○NP ○CP ●PC

HJ-14

H-14 : 2 Pcs	kg/Set : 0.335
H-6 : 4 Pcs	Sets/Ctn : 4 / 45
N-1/N-2 : 4 Sets	

HJ-14A

H-14 : 2 Pcs	kg/Set : 0.135
N-1/N-2 : 2 Sets	Sets/Ctn : 4 / 150

HJ-15

H-15 : 1 Pc	kg/Set : 0.095
H-16 : 1 Pc	Sets/Ctn : 4 / 200
N-1/N-2M612 : 1 Set	

HJ-15A

H-15 : 1 Pc	kg/Set : 0.095
H-16A : 1 Pc	Sets/Ctn : 4 / 200
N-2M612 : 1 Set	

HJ-17

H-17 : 1 Pc	kg/Set : 0.150
H-18 : 1 Pc	Sets/Ctn : 4 / 100
N-1/N-2 : 1 Set	

HJ-19

H-19 : 2 Pcs	kg/Set : 0.155
P-6 : 2 Pcs	Sets/Ctn : 4 / 50
N-1/N-2 : 1 Set	

HJ-20

H-20 : 2 Pcs	kg/Set : 0.150
N-1/N-2 : 1 Set	Sets/Ctn : 4 / 90

HJ-20A

H-20 : 1 Pc	kg/Set : 0.150
H-1 : 1 Pc	Sets/Ctn : 4 / 120
N-1/N-2 : 1 Set	

HJ-21

H-21 : 2 Pcs	kg/Set : 0.280
N-1/N-2 : 1 Set	Sets/Ctn : 4 / 70

HJ-23

H-23 : 2 Pcs	kg/Set : 0.150
P-6 : 1 Pcs	Sets/Ctn : 4 / 60
N-1/N-2 : 1 Set	

HJ-24

H-24 : 2 Pcs	kg/Set : 0.235
P-6 : 1 Pc	Sets/Ctn : 4 / 70
N-1/N-2 : 2 Sets	

HJ-30

H-30 : 2 Pcs	kg/Set : 0.135
N-1/N-2 : 1 Set	Sets/Ctn : 4 / 150

HJ-45

H-45 : 2 Pcs	kg/Set : 0.145
N-1/N-2 : 1 Set	Sets/Ctn : 4 / 100

HJ-60

H-60 : 2 Pcs	kg/Set : 0.180
N-1/N-2 : 1 Set	Sets/Ctn : 4 / 70

HJ-90

H-90 : 2 Pcs	kg/Set : 0.225
N-1/N-2 : 2 Sets	Sets/Ctn : 4 / 75

HJ-110

H-110 : 2 Pcs	kg/Set : 0.250
N-1/N-2 : 2 Sets	Sets/Ctn : 4 / 70

HJ-160

H-160 : 2 Pcs	kg/Set : 0.250
N-1/N-2 : 2 Sets	Sets/Ctn : 4 / 70

HJ-180

H-180 : 2 Pcs	kg/Set : 0.155
N-1/N-2 : 1 Set	Sets/Ctn : 4 / 140



## METAL JOINTS (Φ33)

SURFACE : ●BK ○WZ ○NP ○CP ●PC

### HJ-103



### HJ-403



### HJ-13C



### HJ-13D



## METAL JOINTS (Φ28.6)

### HJ-101



### HJ-102



### HJ-201



### HJ-301



### HJ-401

